

Brilliant Mark HK Ltd
bm@bmbm.hk
Tel: 28828390
Fax: 28828395
www.brilliantmark.com
www.bmbm.hk

aoiga

Professional Hotel Electrical Appliances Brand

PRODUCT CATALOG

COMPANY

PROFILE

AOLGA
Professional Hotel Electrical Appliances Brand

Relying on Hong Kong and based in Shenzhen, Aolga has been adhering to the business concept of being pragmatic, efficient, stable and reliable facing the world since its establishment. With the goal of creating a world-class brand of safe and reliable high-end hotel electrical products, Aolga provides our customers with exquisite and high-quality hospitality appliances through the integration of R&D, manufacturing and sales.



German Gs certification



European CE certification



International CB electrician certification



U.S. FDA certification



International EMC electromagnetic certification

CATALOGUE

A	Hair Dryer
B	Electric Kettle
C	Coffee Maker
D	Retro Minibar
E	Absorption Minibar
F	Thermoelectric Minibar
G	Thermoelectric Minibar(Heat Pipe)
H	Hand-held decoder
I	Hotel Room Safes

J	Bank/Hotel Guest Deposit Box
K	Fireproof Safe
L	Electric Iron
M	Iron Board
N	Weight Scale
O	Alarm Clock
P	Cosmetic Mirror
Q	Emergency Flashlight
R	Luggage Rack
S	Clothes Hanger

High Speed Hair Dryer DF21

- High-speed motor with 110,000r/min
- 23m/s large wind speed
- 200,000,000 negative ions
- 59dB acoustic noise reduction
- Hot, warm and cold air circulating
- 2 wind speed options, 4 temperature controlled options
- Motor protection/Overheat protection/Constant temperature detection/Wind blocking protection
- Color: Gray/White

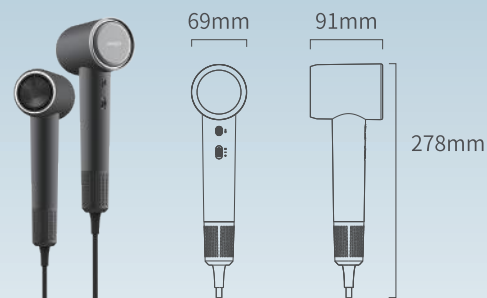

Rated Power	Voltage	Rated Frequency
1600W	220-240V~/120V~	50Hz/60Hz
Power Cable	G.W.	Master Carton Size
1.8M	1.25KG/PC	W530xD333xH351MM



High Speed Hair Dryer ZCY887-B

- 110,000r/min high-speed brushless motor
- 22m/s large wind speed
- 200,000,000 negative ions
- 59dB low noise
- Hot, warm and cold air circulating
- 2 wind speed options, 4 temperature controlled options
- Hot & Cool air switch
- Motor protection/Overheat protection/Constant temperature detection/Wind blocking protection
- Color: Gray/White

Rated Power	Voltage	Rated Frequency	Power Cable	G.W.	Dimensions
1500W	220-240V~	50Hz/60Hz	1.6M	1.04KG/PC	W71xD90xH276MM

OPTIONAL ACCESSORIES

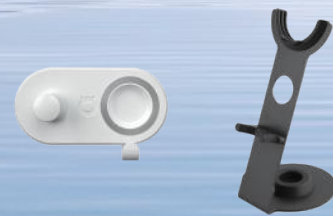

High Speed Hair Dryer A1

- 110,000r/min high-speed brushless motor
- 20m/s large wind speed
- 200,000,000 negative ions
- Hot, warm and cold air circulating
- 2 wind speed options, 4 temperature controlled options
- Hot & Cool air switch
- Motor protection/Overheat protection/Constant temperature detection/Wind blocking protection
- Color: Gray/White

Rated Power	Voltage	Rated Frequency	Power Cable	G.W.	Master Carton Size
1500W	220-240V~	50Hz/60Hz	1.6M	0.58KG/PC	W403xD320xH320MM

High Speed Hair Dryer A1S

- 110,000r/min high-speed brushless motor
- 20m/s large wind speed
- 200,000,000 negative ions
- Hot, warm and cold air circulating
- 2 wind speed options, 4 temperature controlled options
- Hot & Cool air switch
- Motor protection/Overheat protection/Constant temperature detection/Wind blocking protection
- LED display
- Color: Gray/White

Rated Power	Voltage	Rated Frequency	Power Cable	G.W.	Master Carton Size
1500W	220-240V~	50Hz/60Hz	1.6M	0.58KG/PC	W403xD320xH320MM



Hair Dryer RM-DF15

- Small and portable use
- DC motor with high torque and high speed
- 6cm \geq 11m/ sairflow speed
- 14L/s greater blasting capacity for fast dry
- Overheating protection to automatically power off
- 2 wind speed options
- 3 temperature controlled options
- Color: Gray/White

Rated Power	Voltage	Rated Frequency	Power Cable	G.W.	Master Carton Size
1800-2000W/1600-1875W	220-240V~/125V~	50Hz/60Hz	2.5M	0.58KG/PC	W575xD387xH278MM

Optional accessories



AOB-021
W272xD182xH94MM
Color: Gray



AOB-011
W250xH350MM
Color: Black

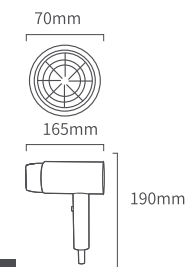

Hair Dryer HD-877

- Retractable cord
- Cool shot function
- Ionic function
- 2 speeds & 3 heat settings
- Removable end cap
- Hang up hook
- Overheating protection
- Color: Gray/White

Rated Power	Voltage	Rated Frequency	G.W.	Dimensions	Master Carton Size
2000W	220-240V~	50Hz/60Hz	0.9KG/PC	W223xD98xH250MM	W485xD310xH270MM



Retractable cord mechanism

Foldable Hair Dryer C203

- 3 temperature controlled options, 2 wind speed options
- Micro safety switch
- Overheating protection
- Powerful DC motor
- Foldable handle optimizes storage space
- Color: Black/White

Rated Power	Voltage	Rated Frequency	Power Cable	G.W.	Dimensions	Master Carton Size
1800W	220-240V~	50Hz/60Hz	1.4M	0.6KG/PC	W201xD78xH130MM	W495xD325xH450MM



Foldable Hair Dryer C201

- 3 temperature controlled options
- 2 wind speed options
- Micro safety switch
- Overheating protection
- Powerful DC motor
- Foldable handle for convenient storage
- Color: Black/White

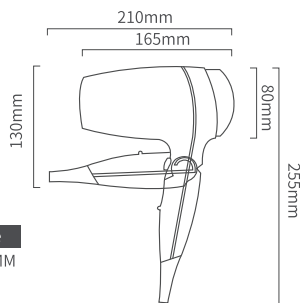

Rated Power	Voltage	Rated Frequency	Power Cable	G.W.	Master Carton Size
1800W	220-240V~	50Hz/60Hz	1.4M	0.6KG/PC	W495xD325xH450MM



Hair Dryer C189/C309

- 3 temperature controlled options
- 2 wind speed options
- Micro safety switch
- Overheating protection
- Powerful DC motor
- Color: Black/White

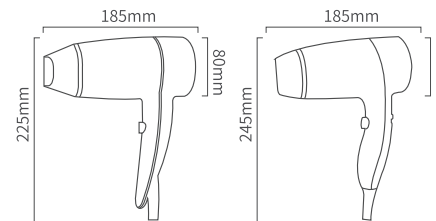

Model	C189	C309
Rated Power	1800W	1800W
Voltage	220-240V~	220-240V~
Rated Frequency	50Hz/60Hz	50Hz/60Hz
Power Cable	1.4M	1.4M
G.W.	0.69KG/PC	0.75KG/PC
Master Carton Size	W515xD395xH510MM	W515xD395xH510MM



C189



C309

Hair Dryer C187

- 2 temperature controlled options
- 2 wind speed options
- Micro safety switch
- Overheating protection
- Powerful DC motor
- Color: Black/White

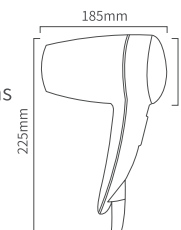

Rated Power	Voltage	Rated Frequency	Power Cable	G.W.	Master Carton Size
1200W	220-240V~	50Hz/60Hz	1.4M	0.75KG/PC	W515xD395xH510MM



C187

Wall-Mounted Hair Dryer RCY-67480/RCY-67600D

- 3 temperature controlled options
- 2 wind speed options
- Micro safety switch
- Overheating protection
- Powerful DC motor
- Dual voltage (220V/110V)
- Color: Black/White

Wall-Mounted Hair Dryer RCY-67588B

- With shaver sockets: dual voltage(110V~/220V~)
- Famous brand DC motor with high torque and high speed
- Wall-mounted
- More concentrated wind and high efficient drying coming from pressurized wind-gathering outlet
- Overheating protection
- 2 wind speed options and 2/3temperature controlled options
- Micro safety switch
- Color: Black/White

Model	RCY-67480	RCY-67600D	RCY-67588B
Rated Power	1200W	1800W	1600W/1800W
Voltage	220-240V~	220-240V~	110-127V~/220-240V~
Rated Frequency	50Hz/60Hz	50Hz/60Hz	50Hz/60Hz
Dimensions	W235xD150xH250MM	W170xD100xH240MM	W225xD145xH250MM
G.W.	1.48KG/PC	1.25G/PC	1.42KG/PC
Master Carton Size	W555xD445xH365MM	W475xD385xH320MM	W555xD365xH445mm



RCY-67480

RCY-67600D



RCY-67588B

Wall-Mounted Hair Dryer D158/RCY-67480T/RCY-67300B

- 3 temperature controlled options
- 2 wind speed options
- Micro safety switch
- Overheating protection
- Powerful DC motor
- Color: Black/White

Model	D158	RCY-67480T	RCY-67300B
Rated Power	1600W/1800W	1600W	1200W
Voltage	110-127V~/220-240V~	220-240V~	220-240V~
Rated Frequency	50Hz/60Hz	50Hz/60Hz	50Hz/60Hz
Dimensions	W345xD150xH265MM	W235xD150xH250MM	W230xD110xH205MM
G.W.	1KG/PC	1KG/PC	1KG/PC
Master Carton Size	W515xD395xH360MM	W555xD445xH365MM	W475xD385xH320mm



D158



RCY-67480T

Wall-Mounted Hair Dryer RCY-67600B

- 2 temperature controlled options
- 2 wind speed options
- Micro safety switch
- Overheating protection
- Powerful DC motor
- Color: Black/White

Rated Power	Voltage	Rated Frequency	Dimensions	G.W.	Master Carton Size
1800W	220-240V~	50Hz/60Hz	W170xD100xH240MM	1KG/PC	W475xD385xH320MM



RCY-67300B



RCY-67600B

Wall-Mounted Hair Dryer RCY-67220

- 2 temperature controlled options
- 2 wind speed options
- Micro safety switch
- Overheating protection
- Powerful DC motor
- Color: Black/White

Rated Power	Voltage	Rated Frequency	Power Cable	G.W.	Master Carton Size
1800W	220-240V~	50Hz/60Hz	1.4M	0.6KG/PC	W495xD325xH450MM

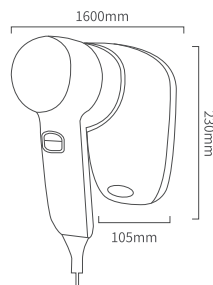

Wall-Mounted Hair Dryer 67220-4

- 2 temperature controlled options
- 2 wind speed options
- Micro safety switch
- Overheating protection
- Powerful DC motor
- Color: Black/White

Rated Power	Voltage	Rated Frequency	G.W.	Master Carton Size
1200W	220-240V~	50Hz/60Hz	1KG/PC	W515xD385xH320MM

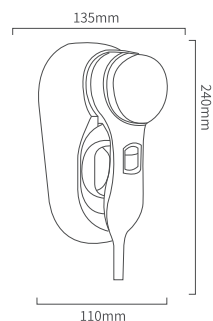

0.7L Electric Kettle EKS06226B-1

- Fashionable appearance and color
- Separate but stable base, which will not make it shake when boiling water
- Food grade SUS304 stainless steel and spray paint craftsmanship
- Auto power off, boil-dry protection
- Color: Gray/Beige

Rated Power	Voltage	Rated Frequency	G.W.	Master Carton Size
800-1000W	220-240V~	50Hz/60Hz	1.15KG/PC	W415xD385xH506MM

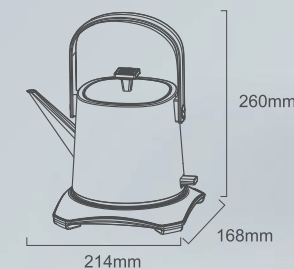

0.7L Electric Kettle EKS06227A-1

- Fashionable appearance and color
- Separate but stable base, which will not make it shake when boiling water
- Food grade SUS304 stainless steel and spray paint craftsmanship
- Auto power off, boil-dry protection
- Color: Gray/Beige

Rated Power	Voltage	Rated Frequency	G.W.	Master Carton Size
800-1000W	220-240V~	50Hz/60Hz	1.15KG/PC	W415xD385xH506MM



1.2L Electric Kettle HOT-W15

- Double-layer pot body
- Humanized design one push open
- Automatic power off
- Aluminum inner pot + ceramic oil
- 70° opening design prevent vapor scalding
- Anti-dry burning double protection
- Color: White

Rated Power	Voltage	Rated Frequency	Power Cable	G.W.	Dimensions
1360W	220-240V~	50Hz/60Hz	0.8M	1KG/PC	W210xD110xH243MM



0.6L Digital Electric Kettle EKS06618YF-4

- SUS304 with matt finishing or painting
- Digital control panel with touch function
- Keep warm and boil up function
- Temperature selection from 45°C to 100°C
- UK STRIX thermostat
- Gooseneck spout
- Boil Dry Protection
- Color: Black

Rated Power	Voltage	Rated Frequency	Power Cable	G.W.	Master Carton Size
800-1000W	220-240V~	50Hz/60Hz	0.75M	1.6KG/PC	W570xD250xH510MM



GL-B04E5B (1.2L)

- Real-time and instant temperature display
- UK STRIX thermostat
- 0.5mm thickened SUS304 stainless steel
- Anti-scalding silicone pad
- Automatic power-off
- 360 degrees rotating base, free rotation to add water in any direction
- Color: Silver grey/White



LL-8877 (1.0L)

- Double-layer design
- SUS304 stainless steel integrated seamless liner
- Water-gathering ring design of upper cover for anti-scalding
- Automatic power-off
- Visible heating indicator
- Color: Gray

Model	GL-E5B	LL-8877	EKS08125
Rated Power	1350-1600W/1000W	1350W	1200W
Voltage	220-240V~/110V~	220-240V~/110V~	220-240V~
Rated Frequency	50Hz/60Hz	50Hz/60Hz	50Hz/60Hz
Power Cable	0.8M	0.8M	0.75M
Dimensions	W230xD170xH230MM	W197.5xD148xH205MM	W193xD103xH209MM
G.W.	0.95KG/PC	1.18KG/PC	0.95G/PC

EKS08125 (0.8L)

- SUS304 stainless steel multi-function kettle
- 4 heat settings with real-time temperature display
- Touch switch
- Double-layer design
- Integrated seamless liner
- Automatical power-off and boil-dry protection
- Color: Black



LL-8860 (0.8L)/LL-8865 (1.0L)

- Double-layer pot body
- SUS304 inner pot and stainless steel cover
- High quality temperature controller
- Dry burning protection
- Automatic power-off
- Color: Black/White(LL-8860); Black/Stainless steel color(LL-8865)

LL-8516 (1.0L)

- SUS304 inner pot and stainless steel cover
- High quality temperature controller
- Automatic power-off
- Anti-dry burning double protection
- Open the lid with one button on the handle
- Color: Silver

Model	LL-8860	LL-8865	LL-8516
Rated Power	1000W	1000W	1000W
Voltage	220-240V~/110V~	220-240V~/110V~	220-240V~/110V~
Rated Frequency	50Hz/60Hz	50Hz/60Hz	50Hz/60Hz
Power Cable	0.8M	0.8M	0.8M
Dimensions	W202.2xD136.7xH201.1MM	W204xD137xH221MM	W180xD138xH203MM
G.W.	1.14KG/PC	1.26KG/PC	0.98KG/PC
Master Carton Size	W585xD395xH410MM	W510xD425xH540MM	W680xD385xH420MM

Optional accessories



- AKT-006
- Rubber Wood
- W420xD380xH30MM



- AKT-007
- Rubber Wood
- W450xD250xH30MM



- AKT-008
- Rubber Wood
- W250xD250xH30MM



LL-8860



LL-8516



LL-8865

LL-8710D (1.0L)

- Double-layer pot body
- 304 food grade stainless steel seamless liner
- Be with water level window
- Automatic/manual switch off
- Separate base and 360° cordless operation to allow removal and replacement from any angle
- Color: Black

Rated Power	Voltage	Rated Frequency	Power Cable	Dimensions	G.W.
1800-2200W	220-240V~	50Hz/60Hz	0.7M	W206xD143xH198MM	0.95KG/PC



K105MN (1.0L)

- 360° rotational stainless steel kettle
- Automatic lid-opening structure
- With removable filter
- Safety locking lid
- With blue LED light
- Automatically/manually switch off
- Color: Stainless steel color

Rated Power	Voltage	Rated Frequency
1850-2200W	220-240V~	50Hz





F-677T(1.7L)

- 360° rotational stainless steel kettle
- Concealed heating element
- Manual lid-opening structure
- With removable filter
- Safety locking lid
- With external water gauge
- Automatically/manually switch off
- With temperature dial
- Color: Stainless steel color

Model	F-677T	K584PN	HOT-W20T
Rated Power	1850-2200W/2520-3000W	1850-2200W/2520-3000W	1500-2000W
Voltage	220-240V~	220-240V~	220-240V~
Rated Frequency	50Hz	50Hz	50Hz



K584PN(1.7L)

- 360° rotational plastic kettle
- Concealed heating element
- Automatic lid-opening structure
- With removable filter
- Safety locking lid
- Indicator light on the switch
- Automatically/manually switch off
- Color: White/Stainless steel color

HOT-W20T(1.7L)

- Double-layer pot body
- Boil-Dry protection
- Keep warm
- Temperature control
- Cordless electric kettle
- Automatic Shut-off
- Color: Stainless steel color



Coffee Maker ST-503D-2e

- Capsule bin with max accommodation of 10 used capsules
- NTC temperature control
- 19 Bar high pressure pump
- Patented brewing group & design
- Compatible capsules: Nespresso Compatible Capsules, Rios Cafe, Nestlé, Starbucks, ILLY, LVAZZA, LOR
- Color: Black/Red/Blue

Rated Power	Voltage	Rated Frequency	Water Capacity	Power Cable	Dimensions	G.W.	Master Carton Size
1260W	220-240V~/120V~	50Hz/60Hz	800ML	1.15M	W350xD100xH260MM	3.8KG/PC	W438xD311xH318MM



Coffee Maker GP100

- ODE imported high pressure pump
- Capsule bin with max accommodation of 6 used capsules
- Customize different cup option
- Adjustable cup height
- NTC temperature control
- Compatible capsules: Nespresso Compatible Capsules, Rios Cafe, Nestlé, Starbucks, ILLY, LVAZZA, LOR
- Color: Black/Red/White

Rated Power	Voltage	Rated Frequency	Water Capacity	Power Cable	Dimensions	G.W.	Master Carton Size
1200W	220-240V~/120V~	50Hz/60Hz	600ML	1.0M	W325xD90xH210MM	3KG/PC	W547xD365xH315MM



Coffee Maker AC-514K

- Nespresso capsule system
- Prebrewing function
- Patented brewing group & design
- Detachable drip tray for easy cleaning, removable water tank
- Compatible capsules: Nespresso Compatible Capsules, Dolce Gusto Capsules, Coffee powder, Coffee pod, Lavazza A Modo Mio, Lavazza Blue, Caffitaly
- Color: Black/Red

Rated Power	Voltage	Rated Frequency	Water Capacity	Power Cable	Dimensions	G.W.	Master Carton Size
1450W	220-240V~/110V~	50Hz/60Hz	600ML	0.9M	W280xD115xH250MM	3.48KG/PC	W595xD330xH295MM



Coffee Maker AC-513K

- Short espress/long nespresso with LED in white
- Stop automatically or manually
- Patented brewing group & design
- Indicating when ready to brew
- Compatible capsules: Nespresso Compatible Capsules, Dolce Gusto Capsules, Coffee powder, Coffee pod, Lavazza A Modo Mio, Lavazza Blue, Caffitaly
- Color: Black and silver

Rated Power	Voltage	Rated Frequency	Water Capacity	Power Cable	Dimensions	G.W.	Gift Box
1450W	220-240V~/120V~	50Hz/60Hz	800ML	0.9M	W312xD170xH295MM	4.03KG/PC	W357xD170xH295MM



K Cup Coffee Maker AC-505K

- Single-cup brewing system for use with K-Cups and ground coffee
- Auto shut off/energy saving
- Retractable pin & residual pressure release to eliminate safety concern
- Stop brewing anytime
- Patented heater for instant brew, benefit to make next brew immediately
- One-touch control panel with illumination
- Removable drip tray
- 45 oz removable clear water reservoir, BPA free
- Fit with refillable holster
- Fit with most standard travel mug
- Color: Black/Red/Silver/Grey

Rated Power	Voltage	Rated Frequency	Water Capacity	G.W.	Gift Box
1420W	220-240V~/120V~	50Hz/60Hz	45OZ	3.7KG/PC	W390xD232xH347MM



K Cup Coffee Maker AC-507K

- Single cup brewing system for use with K-cups
- One-touch control button with illumination
- Detachable lid
- Integrated reservoir, easier access to clean
- Auto shut off after brew
- Retractable probe for safety
- Color: Black

Rated Power	Voltage	Rated Frequency	Water Capacity	G.W.	Gift Box
800W	120V~	60Hz	10OZ	1.3KG/PC	W225xD165xH275MM



Retro Minibar

Comfortable and quality life



Model CB-40SAR

Volume	Rated Power	Voltage
40L	58W	220-240V~/110-120V~
Rated Frequency	N.W./G.W	Dimensions
50Hz/60Hz	12.3/13.8KG	W400xD440xH560MM
Color	● ● ● ○	



Model BC-50BLH(E)

Volume	Rated Power	Voltage
42L	45W	220-240V~/110-120V~
Rated Frequency	N.W./G.W	Dimensions
50Hz/60Hz	18/20KG	W480xD495xH540MM
Color	● ● ● ●	



Model SC-50BLH(E)

Volume	Rated Power	Voltage
40L	45W	220-240V~
Rated Frequency	N.W./G.W	Dimensions
50Hz/60Hz	19/21KG	W480xD495xH540MM
Color	○ ● ● ●	

Absorption Minibar

- No compressor, no noise, suitable for quiet place such as hotels and hospitals
- No freon, no need to add refrigerants, environmental friendly
- No mechanical movement in cooling parts, long life
- Overhead lighting design; adjustable left/right door and shelves
- Using electronic thermostat & IC chip control, auto defrost once a day without artificial defrost troubles
- With a special energy-saving function: using a precise time cycle system to control load operation, saving 17 % power consumption per day
- All structure use imported materials, easy repair and maintenance



Model	M-25A
Volume	25L
Rated Power	60W
Voltage	220-240V~/110-120V~
Rated Frequency	50Hz/60Hz
Dimensions	W400xD360xH473MM
N.W. /G.W.	14/15KG
Color	Gray/Black

Model	M-30A
Volume	30L
Rated Power	60W
Voltage	220-240V~/110-120V~
Rated Frequency	50Hz/60Hz
Dimensions	W400xD420xH490MM
N.W. /G.W.	14.5/15.5KG
Color	Gray/Black

Model	M-40A
Volume	40L
Rated Power	60W
Voltage	220-240V~/110-120V~
Rated Frequency	50Hz/60Hz
Dimensions	W400xD440xH550MM
N.W. /G.W.	17/18.5KG
Color	Gray/Black

Model	M-50A
Volume	50L
Rated Power	60W
Voltage	220-240V~/110-120V~
Rated Frequency	50Hz/60Hz
Dimensions	W400xD440xH665MM
N.W. /G.W.	18.2/20KG
Color	Gray/Black



Model M-25T

Volume	Rated Power	Voltage
25L	60W	220-240V~/110-120V~
Rated Frequency	N.W./G.W.	Dimensions
50Hz/60Hz	15.5/16.5KG	W400xD360xH473MM



Model M-30T

Volume	Rated Power	Voltage
30L	60W	220-240V~/110-120V~
Rated Frequency	N.W./G.W.	Dimensions
50Hz/60Hz	16.5/17.5KG	W400xD410xH493MM



Model M-40T

Volume	Rated Power	Voltage
40L	60W	220-240V~/110-120V~
Rated Frequency	N.W./G.W.	Dimensions
50Hz/60Hz	18/19.5KG	W400xD425xH553MM



Model M-25B

Volume	Rated Power	Voltage
25L	60W	220-240V~/110-120V~
Rated Frequency	N.W./G.W.	Dimensions
50Hz/60Hz	15.5/16.5KG	W400xD360xH473MM



Model M-30B

Volume	Rated Power	Voltage
30L	60W	220-240V~/110-120V~
Rated Frequency	N.W./G.W.	Dimensions
50Hz/60Hz	16.5/17.5KG	W400xD410xH493MM



Model M-40B

Volume	Rated Power	Voltage
40L	60W	220-240V~/110-120V~
Rated Frequency	N.W./G.W.	Dimensions
50Hz/60Hz	18/19.5KG	W400xD425xH553MM

Thermoelectric Minibar

Comfortable and quality life

Black





Model M-22BA

Volume	Rated Power	Voltage
20L	75W	220-240V~/110-120V~
Rated Frequency	N.W./G.W.	Dimensions
50Hz/60Hz	7.2/8.1KG	W360xD353xH440MM



Model M-22BC

Volume	Rated Power	Voltage
20L	75W	220-240V~/110-120V~
Rated Frequency	N.W./G.W.	Dimensions
50Hz/60Hz	9.5/10.4KG	W360xD347xH440MM



Model CB-30SAF

Volume	Rated Power	Voltage
30L	55W	220-240V~/110-120V~
Rated Frequency	N.W./G.W.	Dimensions
50Hz/60Hz	8/9KG	W385xD420xH475MM



Model SC-30SAF

Volume	Rated Power	Voltage
30L	55W	220-240V~/110-120V~
Rated Frequency	N.W./G.W.	Dimensions
50Hz/60Hz	10/11KG	W385xD420xH485MM



Model CB-40SAFN

Volume	Rated Power	Voltage
40L	55W	220-240V~/110-120V~
Rated Frequency	N.W./G.W.	Dimensions
50Hz/60Hz	9.5/10.5KG	W400xD420xH560MM



Model SC-40SAFN

Volume	Rated Power	Voltage
40L	55W	220-240V~/110-120V~
Rated Frequency	N.W./G.W.	Dimensions
50Hz/60Hz	11.5/12.5KG	W400xD420xH570MM

Thermoelectric Minibar(Heat Pipe) Comfortable and quality life

Black



Model CB-45SA

Volume	Rated Power	Voltage	Rated Frequency	N.W./G.W.	Dimensions
45L	58W	220-240V~/110-120V~	50Hz/60Hz	15.5/17KG	W490xD455xH425MM



Model CB-21SA

Volume	Rated Power	Voltage	Rated Frequency	N.W./G.W.	Dimensions
21L	58W	220-240V~/110-120V~	50Hz/60Hz	9.4/10.6KG	W385xD455xH375MM



Model CB-20SA

Volume	Rated Power	Voltage
20L	58W	220-240V~/110-120V~
Rated Frequency	N.W./G.W.	Dimensions
50Hz/60Hz	8.5/9.3KG	W360xD390xH440MM



Model SC-20SA

Volume	Rated Power	Voltage
20L	58W	220-240V~/110-120V~
Rated Frequency	N.W./G.W.	Dimensions
50Hz/60Hz	10/11.1KG	W360xD385xH440MM



Model CB-30SA

Volume	Rated Power	Voltage
30L	58W	220-240V~/110-120V~
Rated Frequency	N.W./G.W.	Dimensions
50Hz/60Hz	10/11.1KG	W385xD420xH475MM



Model SC-30SA

Volume	Rated Power	Voltage
30L	58W	220-240V~/110-120V~
Rated Frequency	N.W./G.W.	Dimensions
50Hz/60Hz	11.4/12.4KG	W385xD420xH485MM



Model CB-40SA

Volume	Rated Power	Voltage
40L	58W	220-240V~/110-120V~
Rated Frequency	N.W./G.W.	Dimensions
50Hz/60Hz	11.8/13KG	W400xD425xH560MM



Model SC-40SA

Volume	Rated Power	Voltage
40L	58W	220-240V~/110-120V~
Rated Frequency	N.W./G.W.	Dimensions
50Hz/60Hz	14/15.2KG	W400xD420xH570MM



Model DT-01

Display	Dimensions	Power Cable	Color
LCD	W152xD86xH34MM	720mm	Gray



Model DT-02

Display	Dimensions	Power Cable	Color
LCD	W130xD64xH28MM	430mm	Black

Hotel Room Safes

- Password: 4 -6 digits.
- International ADA silicone blue backlight buttons available for the blind, which are wear-resistant (more than 100,000 times of service life after being tested).
- LED/LCD display, operation instructions in Chinese and English.
- External backup power interface.
- An electronic code lock system is adopted with programmable CPU
- Three-level management setting system: administrator password (can be disabled), mechanical lock device and electronic decoder, which can check and print more than 200 records of safes' opening and closing recently.
- High-quality, anti-scratch and wear-resistant surface treatment, and the products meet the requirements of international environmental protection organization.
- Solid all-steel lock bolt, and 13-17 inch laptops can be stored well.
- Hidden emergency key hole, being more beautiful and safer.
- Powered by 1.5V AA alkaline batteries with low battery prompt.
- Laser cutting technology on box body makes the surface flat, and brings excellent safety performance.
- High-quality cold-rolled steel plate, which is acid-resistant, anti-corrosion, sturdy and pry-proof.
- RoHS certified environmentally friendly plastic powder and degreasing treatment on the box body makes the surface smooth and the paint durable without color changed.



Model K-FG005B

Display	Dimensions	N.W.	Color
LED	W400xD350xH127MM	9KG/PC	Gray/Black



Model K-FG001

Display	Dimensions	N.W.	Color
LED	W400xD350xH145MM	10.35KG/PC	Gray/Black



Model K-FG800

Display	Dimensions	N.W.	Color
LED	W400xD350xH145MM	11.6KG/PC	Gray/Black



Model K-JG003

Display	Dimensions	N.W.	Color
LED	W420xD380xH200MM	12KG/PC	Gray/Black



Model K-BE003

Display	Dimensions	N.W.	Color
LED	W420xD380xH200MM	9.9KG/PC	Gray/Black



Model K-JG001

Display	Dimensions	N.W.	Color
LED	W420xD380xH200MM	11.2KG/PC	Gray/Black



Model K-JG002

Display	Dimensions	N.W.	Color
LED	W420xD380xH200MM	11.5KG/PC	Gray/Black



Model K-BE100

Display	Dimensions	N.W.	Color
LCD	W420xD380xH200MM	10.3KG/PC	Gray/Black



Model K-BE200

Display	Dimensions	N.W.
LED	W420xD380xH200MM	10.3KG/PC



Model K-BE800

Display	Dimensions	N.W.	Color
LED	W420xD380xH200MM	10.5KG/PC	Gray/Black



Model K-BE200H

Display	Dimensions	N.W.	Color
LED	W400xD390xH500MM	20KG/PC	Gray/Black



Model K-DR200

Display	Dimensions	N.W.
LED	W480xD395xH230MM	15.8KG/PC



10 INCH MODULE

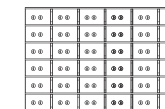
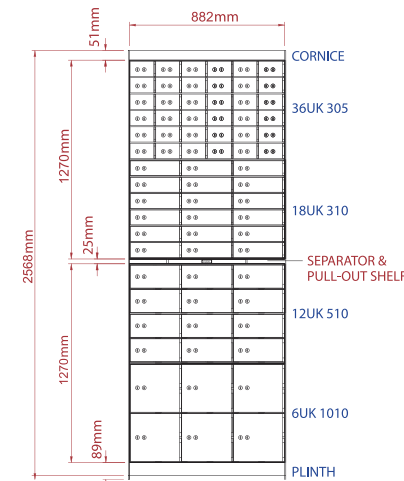

36UK 305 - 36 LOCKERS
NETT WEIGHT : 183KG



30UK 405 30 LOCKERS
NETT WEIGHT : 169KG



24UK 505 - 24 LOCKERS
NETT WEIGHT : 160KG

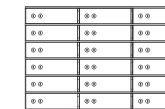

18UK 310 - 18 LOCKERS
NETT WEIGHT : 153KG

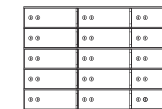

15UK 410 - 15 LOCKERS
NETT WEIGHT : 134KG



12UK 510 - 12 LOCKERS
NETT WEIGHT : 138KG



6UK 1010 - 6 LOCKERS
NETT WEIGHT : 100KG

EXTERNAL DIMENSIONS	
HEIGHT	627 mm
WIDTH	882 mm
DEPTH	450 mm

Bank/Hotel Guest Deposit Box

The combination of advanced mechanical lock technology and traditional hardware technology provides guests with efficient, safe deposit service

Locks:

Using international UL standard of high precision double key lock, master key and guest key used at the same time to open box, the key can't be reproduced

Material: Stainless steel

The thickness of door is 10mm and is made of stainless steel (SUS304)
The box uses high-quality cold-rolled steel



K-BC14

K-BC16

K-BC18

K-BC20

K-BC25



Material:

5mm and 2mm high quality steel plate on the door and box respectively
 Inside box is made of 0.8mm steel plate with being spray processing

Model	Outside size(mm)	Big door size(mm)	Middle door size(mm)	Small door size(mm)	N.W./G.W.(kg)	Color
K-BC14	W800xD450xH930	W410xH245	W410xH150	W195xH110	110/115	Gray/Ivory
K-BC16	W880xD450xH1100	W410xH245	W266.6xH180	W195xH165	122/127	Gray/Ivory
K-BC18	W800xD450xH1270	W410xH225	W410xH150	W195xH110	155/160	Gray/Ivory
K-BC20	W880xD450xH1460	W410xH245	W410xH180	W195xH110	176/181	Gray/Ivory
K-BC25	W880xD450xH1660	W410xH272.5	W266.6xH180	W195xH110	212/217	Gray/Ivory

Handheld Garment Steamer GT100

- Warming up quickly in 30s is almost no need to wait
- Usage includes both flat and hanging ironing
- Aluminum alloy ironing panel
- 180°C steam temperature
- Super large amount of steam
- Automatically power off when no operation for 10 minutes
- Automatic cleaning function
- Overheating protection
- Color: White

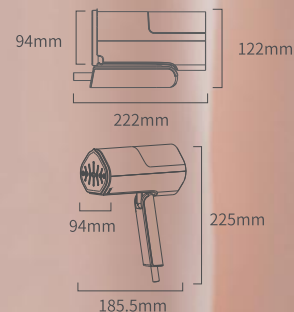

Rated Power	Voltage	Rated Frequency	Water Capacity	Power Cable	G.W.	Master Carton Size
12000W	220-240V~/120V~	50Hz/60Hz	150ML	2.0M	1.45KG/PC	W615xD490xH387MM



Steam Iron SW-605

- Smart steam motion sensor auto cut-off
- Ceramic soleplate
- Adjustable thermostat control
- Variable steam control
- Overheating safety protection
- LED ready indicator
- 3 way automatic shut-off
- Anti-calcium systems
- Color: Black/Light gray and white

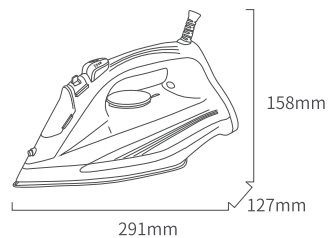

Rated Power	Voltage	Rated Frequency	Water Capacity	Power Cable	G.W.	Master Carton Size
2000W/1200W	220-240V~/120V~	50Hz/60Hz	320ML	1.8M	1.34KG/PC	W690xD332xH345MM

Steam Iron SW-301

- Smart steam motion sensor auto cut-off
- Ceramic soleplate
- Adjustable thermostat control
- Variable steam control
- Overheating safety protection
- LED ready indicator
- 3 way automatic shut-off
- Anti-calcium systems
- Soft rubber button
- Color: Light gray and white



Rated Power	Voltage	Rated Frequency	Water Capacity	Power Cable	Dimensions	G.W.	Master Carton Size
2000W	220-240V~	50Hz/60Hz	300ML	1.8M	W298xD118xH150MM	1.34KG/PC	W635xD330xH340MM

Iron Board 1338

- Various height adjustment up to 78cm
- Mesh ironing top W12xL36 inch [30.5x91.5cm]
- Strong structure legs design
- Stylish iron rest
- Flameproof fabric plus 10mm thickened cotton cushion
- Color: Black

Dimensions	G.W.	Package Standard	Master Carton Size
W1230xD305xH750MM	3.8/KG/PC	4PCS/CTN	W1240xD250xH340MM



Iron Holder TCL-D

- Suitable for different size iron
- ABS moulded, with two silicone strips resistant to high temperature
- Color: Black/White

Dimensions	G.W.	Package Standard	Master Carton Size
W330xD140xH110MM	0.44KG/PC	20PCS/CTN	W845xD343xH306MM



Iron Board 1640T1-28

- Variable height adjustment up to 75cm
- Popular for hotel use
- Flameproof fabric plus 10mm thickened cotton cushion
- Stylish iron rest
- Color: Gray

Dimensions	G.W.	Package Standard	Master Carton Size
W1015xD405xH750MM	6-8KG/PC	2PCS/CTN	W1050xD425xH125MM



Iron Holder 1236H4-16

- Variable height adjustment up to 87cm
- Popular for hotel use
- Flameproof fabric plus 10mm thickened cotton cushion
- Stylish iron rest
- Color: Gray

Dimensions	G.W.	Package Standard	Master Carton Size
W1067xD305xH870MM	6-8KG/PC	6PCS/CTN	W1220xD320xH220MM



Spontaneous Electric Weight Scale CW300

- No battery, patented self-generating electronic scale
- ABS+ architectural grade tempered glass
- High-definition LCD display
- Auto power off/on
- Overload/Low battery prompt
- Humanized design large rounded corners
- Color: Gray/White

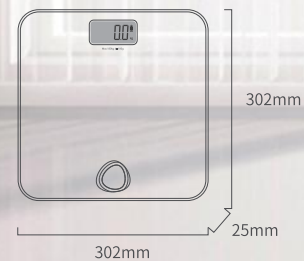

Material	Battery	Weighing Range	G.W.	Master Carton Size
ABS+tempered glass	No battery	3KG-180KG	1.9KG/PC	W330xD330xH250MM



Weight Scale CW276

- Integral body to open and close without screw exposed for being durable and long service life
- 16.2mm thin scale body with lower center of gravity and being more stable when weighing
- Clear LCD digital display with soft white backlight, making it still clear under the low light and dark environment
- High precision sensor system with precision being 0.05kg
- Auto power off/on, overload, low battery prompt
- Color: Wood color

Material	Battery	Weighing Range	G.W.	Master Carton Size
ABS+fireproof material	2x3V CR2032	3KG-150KG	1.38KG/PC	W310xD258xH315MM

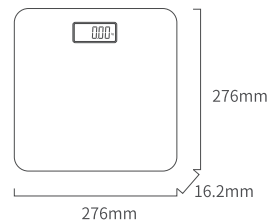

Weight Scale CW269

- Full ABS covered base
- ABS+tempered glass
- Invisible LED display
- 4 high sensitive sensors
- Intelligent automatic switch ON/OFF
- Integrated weighing surface
- Four-point force
- Auto power off/on
- Overload/Low battery prompt
- Color: Black/White

Material	Battery	Weighing Range	G.W.	Master Carton Size
ABS+tempered glass	4x1.5V AAA	5KG-180KG	1.97KG/PC	W445xD400xH360MM

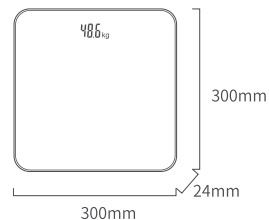

Mechanical Body Scale DP-20

- Excellent weighing experience with high precision G sensors
- High quality tempered glass platform, durable & safe
- Round corners in all directions, ultra user Safety
- Intelligent SENSE ON & AUTO OFF in 30 sec. without operation, overload warning, low battery indication
- Magic lens, large LED & backlight display with eye-catching white readout
- Fitting rubber floor MATS, anti-skid and more stable
- Color: Silver

Material	Battery	Capacity	G.W.	Dimensions	Master Carton Size
Tempered glass	4*AAA	200KG	2.92KG/PC	W355xD355xH38MM	W400xD385xH425MM



Mechanical Body Scale MP-03

- Mechanical weighing gets energy saving
- High strength material with mirror finish
- Cold rolled steel body becomes robust and durable
- 180KG Super resistant to pressure
- High strength metal body
- Anti-slip, digital show
- Large arc design
- Color: Black

Material	Capacity	G.W.	Dimensions	Master Carton Size
ABS+steel plate	180KG	3KG/PC	W365xD360xH65MM	W400xD415xH330MM



Alarm Clock H7

- Bluetooth version 5.0
- Wireless Qi mobile phone charging or charging with the front USB+Type C
- Loudspeaker
- Multi-function with Bluetooth, alarm clock, radio, showing week, TF, disk, AUX,
- Qi wireless charging and playing music features
- LED digital display
- Color: Black/White

AC Input	DC Output	Rated Frequency	G.W.	Dimensions	Master Carton Size
100-240V~	9V/2A transformer	50Hz/60Hz	0.5KG/PC	W150xD90xH75MM	W430xD330xH415MM



Alarm Clock K5

- Bluetooth version 5.0
- Work as a loudspeaker
- Multi-function with Bluetooth, alarm clock, radio, showing time, week, temperature
- Mobile phone charging
- Two USB in the front and one Type C interface for devices charging
- LCD digital display
- NAP and snooze function
- Color: Black/White

AC Input	DC Output	Rated Frequency	G.W.	Dimensions	Master Carton Size
100-240V~	5V/2A transformer	50Hz/60Hz	0.35KG/PC	W127xD50xH78MM	W425xD344xH422MM





● Chrome ● Black

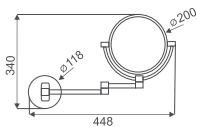
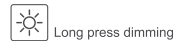

Wal Mounted LED Mirror 214-2

- Size: 8 inches
- Mirror: 3x, 5x
- Material: Brass+Zinc+Stainless steel
- Led light: 5W, 110-260V~
- Light colour: white, warm white, yellow
- Switch: mirror touch switch
- Connect: plug, hard wires in side wall
- Power supplied: AC 110-260V~ used; rechargeable battery
- Plug: EU, BS, US, AU, BRA, SA, IT Plugs ect
- QTY: 20pcs/ctn
- Master carton size: W800xD390×H655MM



● Chrome ● Black

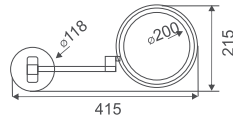
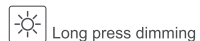

Wal Mounted LED Mirror 261-2

- Size: 8 inches
- Mirror: 3x, 5x
- Material: Brass+Zinc+Stainless steel
- Led light: 5W,110-260V~
- Light colour: white, warm white, yellow
- Switch: mirror touch switch
- Connect: plug,hard wires in side wall
- Power supplied: AC 110-260V~ used; rechargeable battery
- Plug: EU, BS, US, AU, BRA, SA, IT Plugs ect
- QTY: 10pcs/ctn
- Master carton size: W715xD295xH590MM



● Chrome ● Black

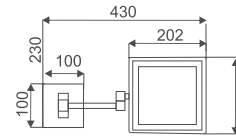
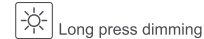

Wal Mounted LED Mirror 262-2

- Size: 202x202MM
- Mirror: 3x, 5x
- Material: Brass+Zinc+Stainless steel
- Led light: 5W, 110-260V~
- Light colour: white, warm white, yellow
- Connect: plug, hard wires in side wall
- Power supplied: AC 110-260V~ used; rechargeable battery
- Plug: EU, BS, US, AU, BRA, SA, IT Plugs ect
- QTY: 10pcs/ctn
- Master carton size: W715xD295×H590MM



● Chrome ● Black

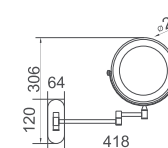
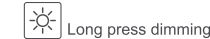

Wal Mounted LED Mirror 995

- Size: 8 inches
- Mirror: 3x, 5x
- Material: Brass+Zinc+Stainless steel
- Led light: 5W/10W, 5V~
- Light colour: white, warm white, yellow
- Connect: rechargeable battery
- Power supplied: single touch three color dimming, long press stepless dimming
- QTY: 20pcs/ctn
- Master carton size: W590xD350×H700MM



● Chrome ● Black

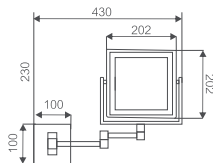

Wal Mounted LED Mirror 260

- Size: 202x202MM
- Mirror: 3x, 5x
- Material: Brass+Zinc+Stainless steel
- Led light: 5W,110-260V~
- Light colour: white,warm white,yellow
- Switch: boat switch
- Connect: plug, hard wires in side wall
- Power supplied: AC 110-260V~ used; rechargeable battery
- Plug: EU, BS, US, AU, BRA, SA, IT Plugs ect
- QTY: 10pcs/ctn
- Master carton size: W400xD390xH645MM



● Chrome ● Black

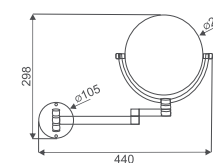

Wall Mounted Cosmetic Mirror 251

- Size: 6 inches, 8 inches
- Mirror: 3x, 5x
- Material: Brass+Zinc+Stainless steel
- QTY: 20pcs/ctn
- Master carton size: W590xD350xH700MM

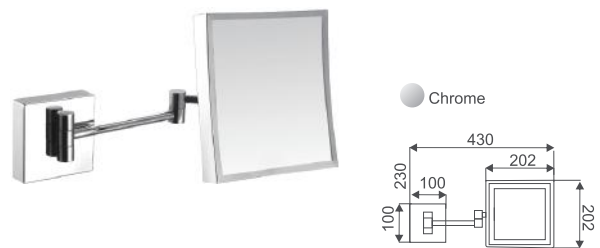

Wall Mounted Cosmetic Mirror 289

- Size: 8 inches
- Mirror: 3x
- Material: Brass+Zinc+Stainless steel
- QTY: 10pcs/ctn
- Master carton size: W715xD295xH590MM

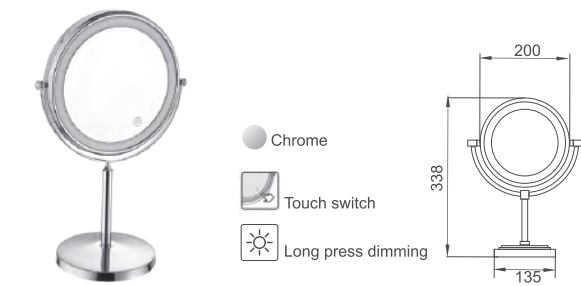

Desktop LED Mirror 505

- Size: 8 inches
- Mirror: 3x, 5x
- Material: Brass+Zinc+Stainless steel
- Led light: 5W/10W, 5V~
- Light colour: white, warm white, yellow
- Connect: rechargeable battery
- Power supplied: single touch three color dimming, long press stepless dimming
- QTY: 20pcs/ctn
- Master carton size: W790xD400xH560MM

Desktop LED Mirror 501

- Size: 8 inches
- Mirror: 3x, 5x
- Material: Brass+Zinc+Stainless steel
- Led light: 5W,110-260V~
- Light colour: white,warm white,yellow
- Connect: plug
- Power supplied: AC 110-260V~ used; rechargeable battery
- Plug: EU, BS, US, AU, BRA, SA, IT Plugs ect
- QTY: 8pcs/ctn
- Master carton size: W745xD440xH645MM

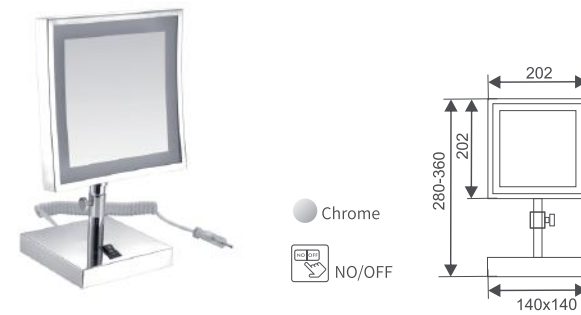

Desktop LED Mirror 266

- Size: 202x202MM
- Mirror: 3x, 5x
- Material: Brass+Zinc+Stainless steel
- Led light: 5W,110-260V~
- Light colour: white, warm white, yellow
- Connect: plug
- Power supplied: AC 110-260V~ used; rechargeable battery
- Plug: EU, BS, US, AU, BRA, SA, IT Plugs ect
- QTY: 8pcs/ctn
- Master carton size: W745xD440xH645MM

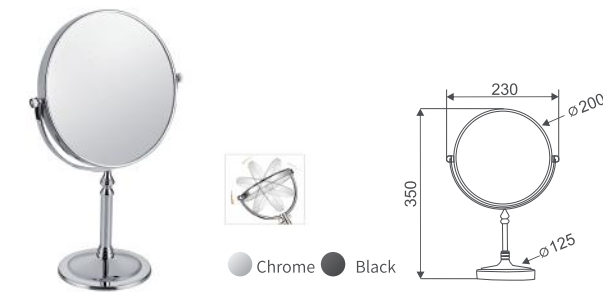
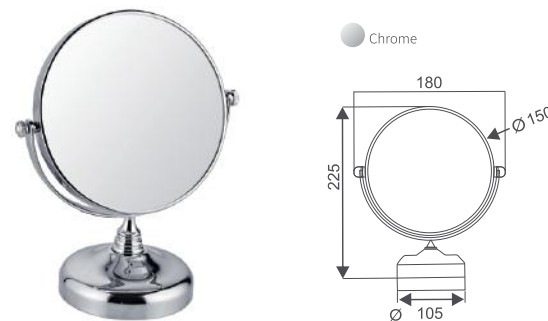

Desktop Cosmetic Mirror 226

- Size: 6 inches, 8 inches
- Mirror: 3x, 5x
- Material: Brass+Zinc+Stainless steel
- QTY: 20pcs/ctn
- Master carton size: W790xD400xH560MM

Desktop Cosmetic Mirror 235

- Size: 6 inches
- Mirror: 3x, 5x
- Material: Brass+Zinc+Stainless steel
- QTY: 20pcs/ctn
- Master Carton Size: W810xD400xH560MM

Wall Mounted Emergency Flashlight NE2020-B

- Brighter light source Escape is brighter: 1w high-brightness
- LED lightsource, continuous lighting for more than 10 hours, in line with fireprotection standards
- Environmental protection and energy saving charging indication: charging(red light) / fully charged (green light)
- Six-series aviation aluminum body with high temperature resistanceand anti-theft design
- Dimensions: W150xD37xH40MM
- G.W.: 0.16KG/PC
- Color: Black



Wall Mounted Emergency Flashlight NE2006-B

- 13 LED rechargeable
- Aviation aluminum alloy body with non-slip handle
- Energy saving charging
- Fire emergency, pick up and light up
- Dimensions: W192xD60xH55MM
- G.W.: 0.35KG/PC
- Color: Black

Model YDXL-01

- Foldable wooden luggage rack
- Strong straps to carry sufficient weight
- Less damage to the walls due to the design
- Space saving model without backrest
- Flat when folded

Material	Dimensions
Walnut brown	W600xD400xH600MM



Model YDXL-02

Material	Dimensions
Walnut brown	W600xD445xH670MM



Model YDXL-03

Material	Dimensions
Walnut brown	W600xD400xH500MM



Model YDXL-06

Material	Dimensions
201 Stainless steel	W550xD400xH500MM



Model YDXL-07

Material	Dimensions
201 Stainless steel	W550xD500xH700MM



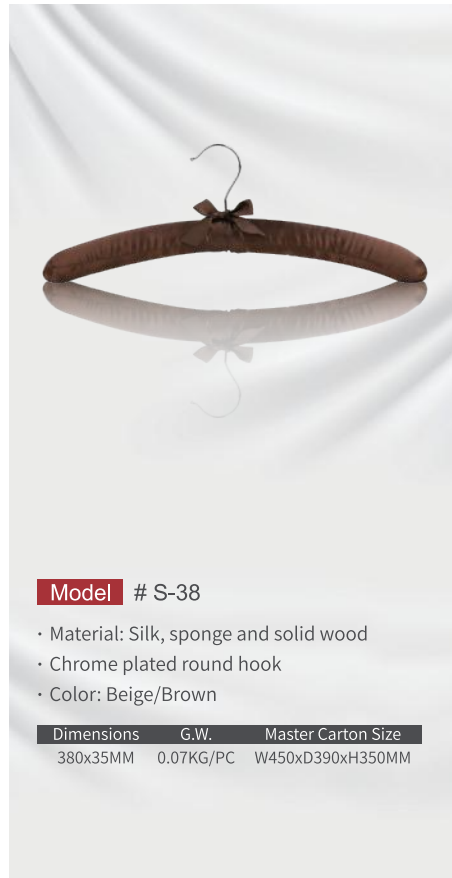

Model # S-38

- Material: Silk, sponge and solid wood
- Chrome plated round hook
- Color: Beige/Brown

Dimensions	G.W.	Master Carton Size
380x35MM	0.07KG/PC	W450xD390xH350MM



Model #661211

- Chinese cherry wood
- Hanger for T-Shirt
- Chrome plated round hook
- Chrome plated rod with clips
- Wood color

Dimensions	G.W.	Master Carton Size
445x12MM	0.15KG/PC	W370xD370xH530MM



Model #9702

- Chinese cherry wood
- Hanger for suit
- Chrome plated oblate hook
- Rubber round rod
- Wood color

Dimensions	G.W.	Master Carton Size
445x13-55MM	0.22KG/PC	W380xD380xH370MM



Model #302016

- Chinese cherry wood
- Hanger with groove for T-Shirt
- Chrome plated oblate hook
- Chrome plated rod with clips
- Wood color

Dimensions	G.W.	Master Carton Size
445x20MM	0.29KG/PC	W380xD380xH530MM



Model #661218

- Chinese cherry wood
- Hanger with groove for T-Shirt
- Chrome plated round hook
- Chrome plated rod with clips
- Wood color

Dimensions	G.W.	Master Carton Size
445x12mm	0.16KG/PC	W370xD370xH600MM



Model #908

- Chinese cherry wood
- Hanger for pants
- Chrome plated round hook
- Chrome plated rod with clips
- Wood color

Dimensions	G.W.	Master Carton Size
350x12MM	0.12KG/PC	W460xD370xH340MM



Model #808

- Chinese cherry wood
- Hanger for pants
- Chrome plated round hook
- Chrome plated rod with clips
- Wood color

Dimensions	G.W.	Master Carton Size
350x12MM	0.11KG/PC	W370xD360xH340MM